

Introduction The DceL DT is a low profile dual toxic sensor, ideal for multi-gas portable gas detectors.

Key Features: high stability, fast response and recovery, low H₂S cross sensitivity on CO electrode

Performance Characteristics	CO Channel	H ₂ S Channel
Output signal	40-70nA/ppm	200-400nA/ppm
Typical Baseline Range (pure air)	±3 ppm CO equivalent	± 1 ppm H ₂ S equivalent
Filter Capacity	> 15,000 ppm hours	-
T90 Response Time	< 30 seconds	< 30 seconds
Measurement Range	0 - 1000 ppm	0 - 100 ppm
Maximum Overload	2000 ppm	400 ppm
Linearity	Linear	Linear
Repeatability	< ±3% CO equivalent	< ±2% H ₂ S equivalent
Recommended Load Resistor	10 ohms	10 ohms
Resolution (Electronics dependent)	±1 ppm CO typical	±0.5 ppm H ₂ S typical

Environmental Details	
Temperature Range Continuous	-30°C to +50°C
Pressure Range	800 to 1200 mbar
Operating Humidity Range	15% to 90% RH

Important Note:

All performance data is based on conditions at 20°C, 50%RH and 1 atm, using DD Scientific recommended circuitry.

Sensor performance is temperature dependent, and please contact DD Scientific for temperature performance other than 20°C.

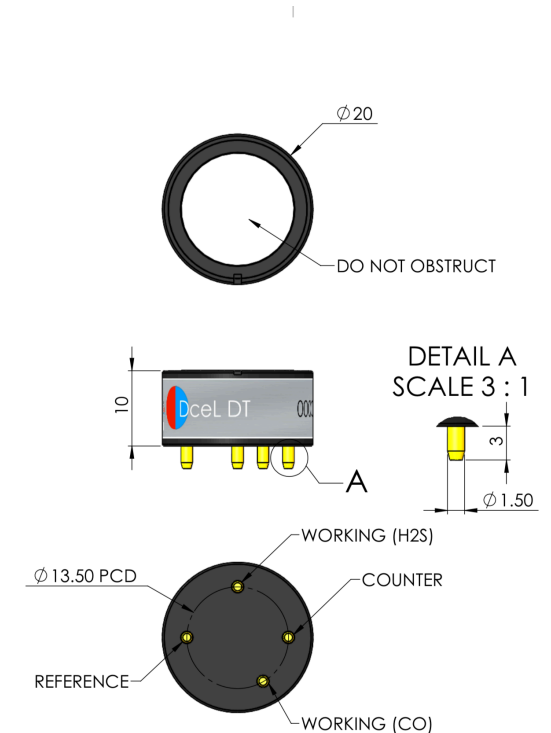

ALL TOLERANCES UNLESS STATED: ±0.15mm

Product Dimensions

All dimensions in mm

All tolerances ±0.15 mm

Lifetime Details	
Long Term Output Drift	< 10% per annum
Recommended Storage Temp	0°C to 20°C
Expected Operating Life	> 24 months in air
Standard Warranty	12 months from date of dispatch

Temp data TBC

Cross - Sensitivity Data			
GAS	CONC.	CO Channel	H ₂ S Channel
Hydrogen Sulphide	25 ppm	< 5 ppm	25 ppm
Sulphur dioxide	5 ppm	0 ppm	< 1 ppm
Hydrogen	100 ppm	<30 ppm	< 0.05 ppm
Nitric Oxide	35 ppm	< 0.1ppm	< 1 ppm
Carbon Monoxide	300 ppm	300 ppm	< 6 ppm
Nitrogen Dioxide	5 ppm	< 0.1 ppm	0 ppm
Chlorine	15 ppm	0 ppm	0 ppm

Poisoning:

DD Scientific sensors are designed to operate in a wide range of harsh environments and conditions. However, it is important that exposure to high concentrations of solvent vapors is avoided, both during storage, fitting into instrument and operation. When using sensors on printed circuit boards (PCB's), degreasing agents should be used prior to the sensor being fitted.

Please note gluing or soldering direct to the pins of DD Scientific Ltd gas sensors will void warranty, please use PCB sockets when

Intrinsic Safety Data	
Maximum at 2000 ppm	0.3 mA
Maximum o/c Voltage	1.3 V
Maximum s/c Current	<1.0 A

WARNING: By the nature of the technology used, any electrochemical gas sensor offered by DD Scientific can potentially fail to meet specification without warning. Although DD Scientific Ltd makes every effort to ensure the reliability of our products of this type, where life safety is a performance requirement of the product, we recommend that all sensors and instruments using these sensors are checked for response to gas before use.

Every effort has been made to ensure the accuracy of this document at the time of printing. In accordance with the company's policy of continued product improvement DD SCIENTIFIC Limited reserves the right to make product changes without notice. No liability is accepted for any consequential losses, injury or damage resulting from the use of this document or from any omissions or errors herein. The data is given for guidance only. It does not constitute a specification or an offer for sale. The products are always subject to a program of improvement and testing which may result in some changes in the characteristics quoted. As the products may be used by the client in circumstances beyond the knowledge and control of DD SCIENTIFIC Limited, we cannot give any warranty as to the relevance of these particulars to an application. It is the clients' responsibility to carry out the necessary tests to determine the usefulness of the products and to ensure their safety of operation in a particular application. Performance characteristics on this data sheet outline the performance of newly supplied sensors. Output signal can drift below the lower limit over